

ITSCC0101040T2D15

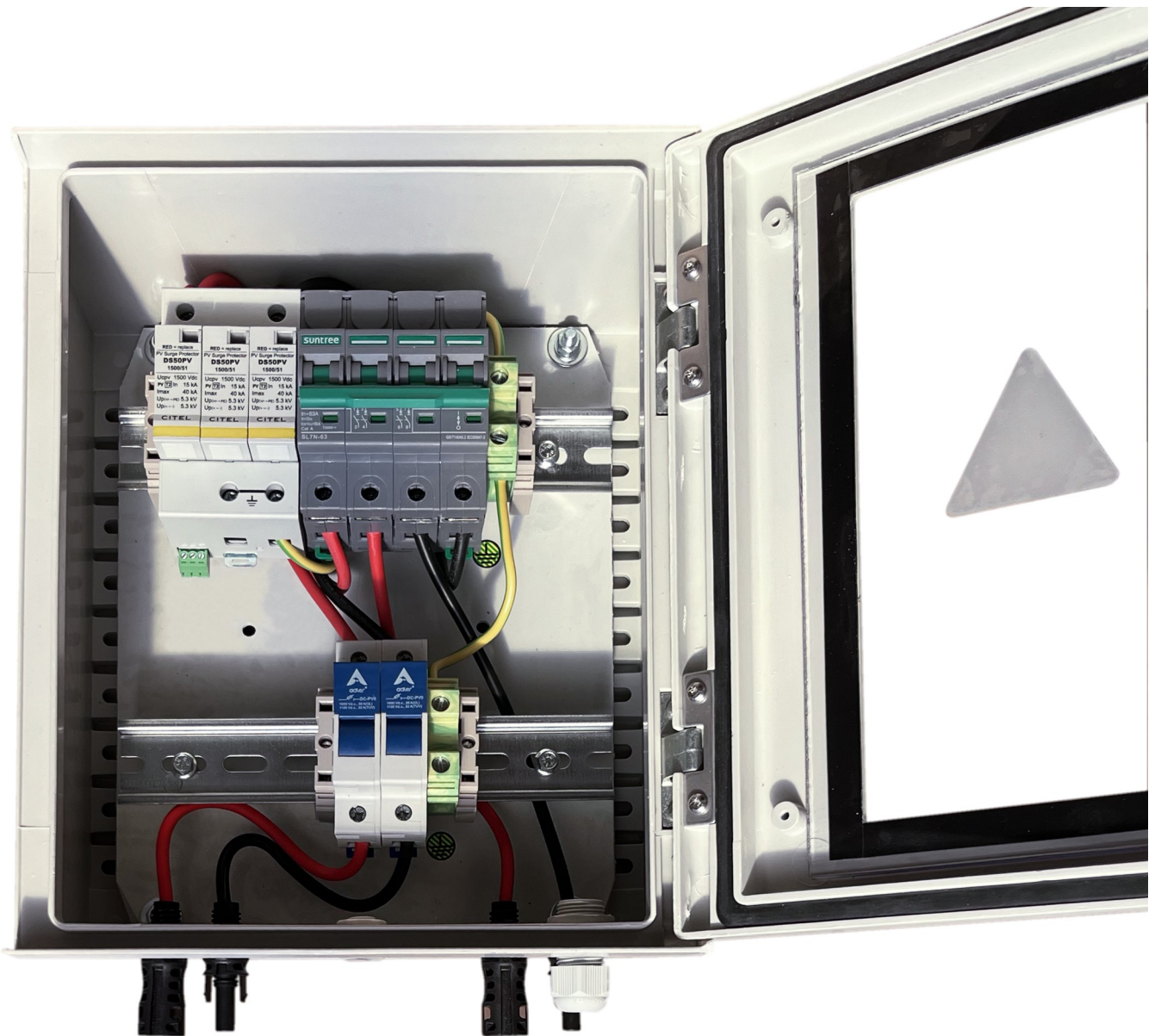

Installation and Operation Manual



rev. 1.0
24 April 2024

INDEX

1 BEFORE TO START.....	4
2 GENERAL NOTES.....	5
3 SAFETY INSTRUCTION.....	5
4 OVERVIEW.....	7
4.1 Block Diagram.....	7
5 INSTALLATION.....	8
5.1 Front View.....	8
5.2 Bottom View.....	9
5.3 Naming Convention.....	10
5.4 Staubli MC4 Connectors.....	11
6 TECHNICAL DATA.....	12
6.1 Parameters.....	12
6.2 Mechanics Characteristics.....	12
6.3 Dimensions and Weight.....	12
7 MAINTENANCE.....	13



Warning : Qualified Technical Personnel

All work must be carried out by qualified personnel. Operations could be dangerous to you and other people using this equipment. For safety reasons, all installation and wiring connections must be made by qualified technical personnel only.

Use installation tools suitable for system voltages. Protective gloves should be used against electrical hazards.

During its installation and operation, the personal safety regulations in force in the system for which the product is intended are mandatory.

It is recommended not to wear loose clothing or other clothing or accessories that could come into contact with the components of the SCC, especially the metal parts.

SCC's work with direct voltage which can reach up to 1500V. Its manipulation is highly dangerous, which can cause severe burns and even death if are not taken preventive measures or is handled by unqualified personnel.



Maintenance

Always use a suitable voltage sensing device to confirm that the power is off before installing or working with the panel.

Local, state and national regulations and safety practices for this type of equipment must be observed.

Only authorized personnel can access the panel. All maintenance and technical assistance work must be carried out by authorized "Specialized Personnel".

All inspections and tests must be performed with controls and equipment de-energized, disconnected and isolated from accidental contact with live parts, and all plant safety procedures must be followed.

Remember that for any manipulation inside the SCC all the warnings and safety measures indicated in the previous points must be considered.



Manual Management

Please keep this user manual with other related documents, and make sure it is on hand for quick reference.

The manual must always be available for consultation inside the electrical panel and stored properly.

The manual is subject to changes and corrections because of the updates of the product. The actual purchased product shall prevail. Users can get the latest manual from our sales channel or our official website.

Please read this user manual carefully before undertaking the installation.

The manufacturer reserves the right to refuse warranty claims for equipment damage if the user fails to install the equipment as per the instructions in this manual.

Follow scrupulously all indication reported in this manual.



General Warning

*It is mandatory to read this user manual in its entirety before proceeding with the installation, use and maintenance of this equipment by qualified technical personnel.
Follow scrupulously all indication reported in this manual.*

This equipment is manufactured in compliance with current safety standards, therefore it is recommended that you use all of these devices and make sure that their use does not cause damage or injury.

*This electrical panel must only be used for the purpose for which it was expressly designed.
Any other use is to be considered improper and therefore dangerous.*

*Disconnect the equipment in case of malfunction.
Before performing any maintenance operation, disconnect the equipment.
Do not handle or manipulate the panels in the presence of water, rain or condensation.
See the instructions on the disconnection of the equipment.*

All electrical installations must be carried out in accordance with local building codes and local authority requirements.

It's mandatory to install SCC in the environment conditions indicated on technical characteristics, which were design requirements, for its right operation.

Any connection work must be done with the equipment unplugged. The disconnection from the main switch and the isolation of the input circuits from the photovoltaic modules does not guarantee the total absence of dangerous voltages inside the SCC. To access the conductive parts of the equipment safely, it is essential to isolate it from the inverter line (outputs), from the direct current lines of the solar panels (inputs) and from the external power supply line of the electronic equipment (if any).

1 BEFORE TO START

- Examine all components before connecting. Internal connections must be carefully inspected before installation.
- Check cable connections and check the fixing of the non-active parts whose function is the protection against direct contacts of the active parts.
- General cleaning: Remove any internal objects (wire pieces, screws, nuts, wires...), insects, dust and dirt.
- Do not install the panel near any flammable or corrosive substance.
- Check the correct tightening torque of the electrical connections to avoid bad contacts.
Incorrect tightening or low wire cross section may cause fire and shock hazard as well as shorten the life of this product.

2 GENERAL NOTES







Thank you for choosing this PV String Combiner (simply called "SCC" in the following of this manual).

This String Combiner is a highly reliable product.

This manual mainly includes product description, installation, safe operation, troubleshooting and other important information of the String Combiner. Please carefully read this manual before you operate on the String Combiner.





3 SAFETY INSTRUCTION

Introduce the safety instructions of operation and maintenance on the SCC.

Icon	Meaning	Description
	DANGER	Indicates a very dangerous situation which, if not avoided, will result in death or serious injury.
	WARNING	Indicates a dangerous situation which, if not avoided, will result in death or serious injury.
	CAUTION	Indicates a dangerous situation which, if not avoided, will result in minor or moderate injury
	INSTRUCTION	Indicates important supplementary information and / or provides skills that can be used to help you solve a problem or save time.
	HIGH VOLTAGE	The product works with high voltages. Everyone works on the product should only be performed as described in this document.
	EARTH GROUND	This symbol indicates the location of the grounding terminal, which must be firmly connected to the earth via the PE (protective earth) cable to ensure operational safety.

*The information contained in this document may change without notice.
Therefore, please check our website (www.solarbox.it) regularly
and always download the latest version available.*

Important Safety Instructions

	<p>DANGER</p>	<ul style="list-style-type: none"> - Do not touch the terminals or conductors connected to PV modules or PV inverters, which could cause death by electric shock! - Contact with wiring terminals inside the device can cause death by electric shock! - SCC works with direct voltage which can reach up to 1500 V. Its handling is highly dangerous, which can cause severe burns and even death if preventive measures are not taken or it is handled by unqualified personnel.
	<p>WARNING</p>	<ul style="list-style-type: none"> - Make sure the DC and AC sources are both disconnected and the device shell is securely grounded to avoid electric shock when servicing or installing the device. - Please check all input and output wire terminals in case of high DC voltage and make sure there is no voltage before electrical connection to avoid electric shock! - Do not touch the live parts of the input and output sides to avoid electric shock when checking or maintaining the device
	<p>CAUTION</p>	<ul style="list-style-type: none"> - Although the SCC is certified according to international safety standards, it becomes hot during operation. Do not touch the hot parts of the device during operation. - All wiring and operation must comply with the requirements of the relevant local standards of the device. - Check the device and make sure there are no problems with the installation before putting it into operation! - Be careful to move the SCC in case of a fall due to the weight of the device! - Although the device is IP66 protection class and can be applied outdoors, do not install the device in humid places or in direct sunlight as it is also an electronic device. - Connect the wires to the positive and negative marked positions of the device to avoid the risk of short circuit, ensure personal safety and keep the device in normal operation. - Pay attention to all wiring and safety instructions for the SCC. - Heavy device, please move carefully!
	<p>INSTRUCTION</p>	<p>The product nameplate contains important information about the device, including model name, lot number, etc. If there is any problem or malfunction of the device during operation, customers can contact us directly and communicate the product serial number and the problem encountered: our assistance staff will do their best to help you promptly. Please keep the identification plate intact.</p>

4 OVERVIEW

Introduce the mechanical structure, schematic diagram, etc. of the SCC.

4.1 Block Diagram

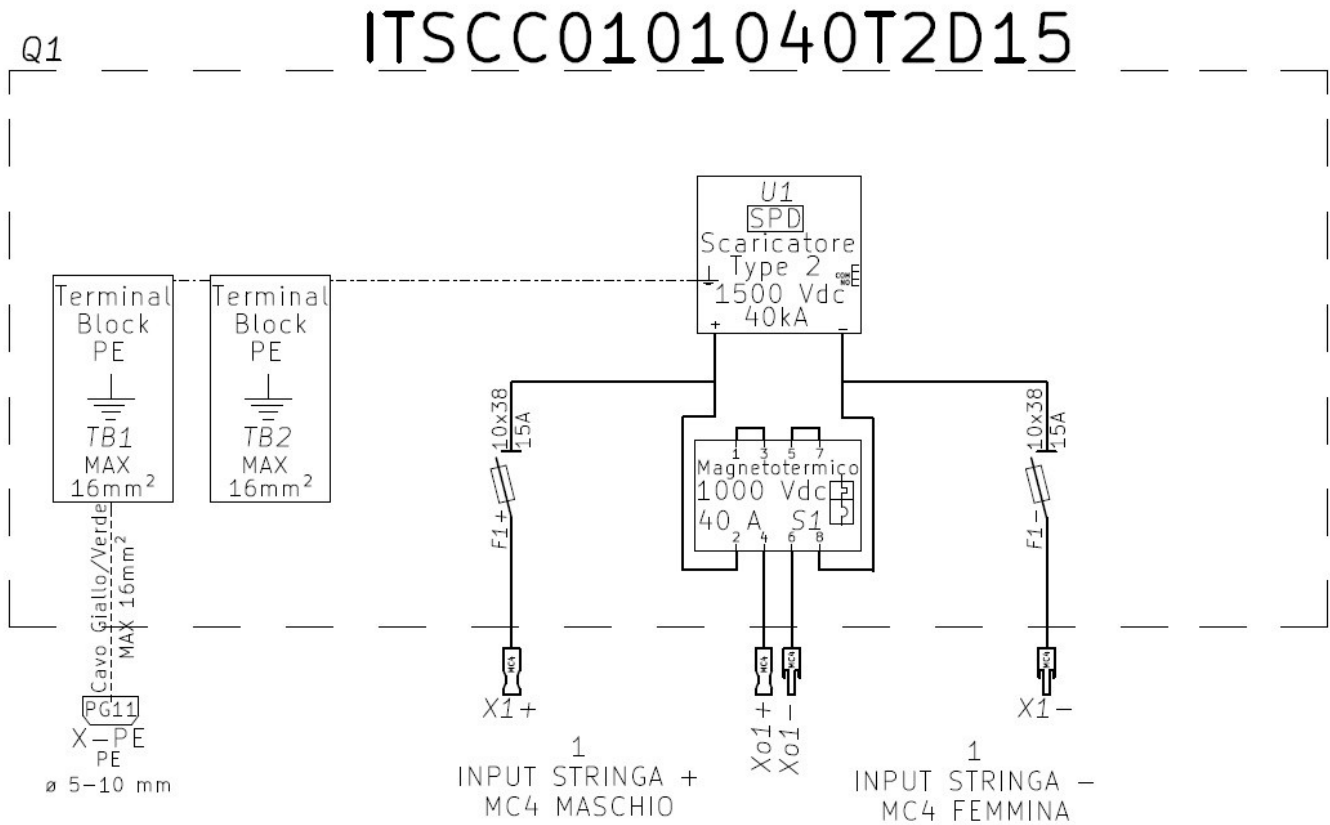

CAVI	
SIMBOLO	DESCRIZIONE
	Cavo SOLARE sezione 4mm ²
	Cavo PE sezione 4mm ²
	Cavi NON montati Intallazione a cura del cliente

COMPONENTI	
SIMBOLO	DESCRIZIONE
	Interruttore di manovra Sezionatore fusibile 10x38 1000V
	Sezionatore Con contatto ausiliario
	SPD Scaricatore di Protezione

CONNESSIONI ESTERNE	
SIMBOLO	DESCRIZIONE
	MC4 - FEMMINA La controparte accetta cavi solari Sezione 4-6-10 mm ²
	MC4 - MASCHIO La controparte accetta cavi solari Sezione 4-6-10 mm ²
	PRESSACAVO ø 5-10 mm Min 1x4mm ² MAX 1x16mm ²

5 INSTALLATION

Introduce the installation, wiring steps and safety instructions of the SCC

5.1 Front View

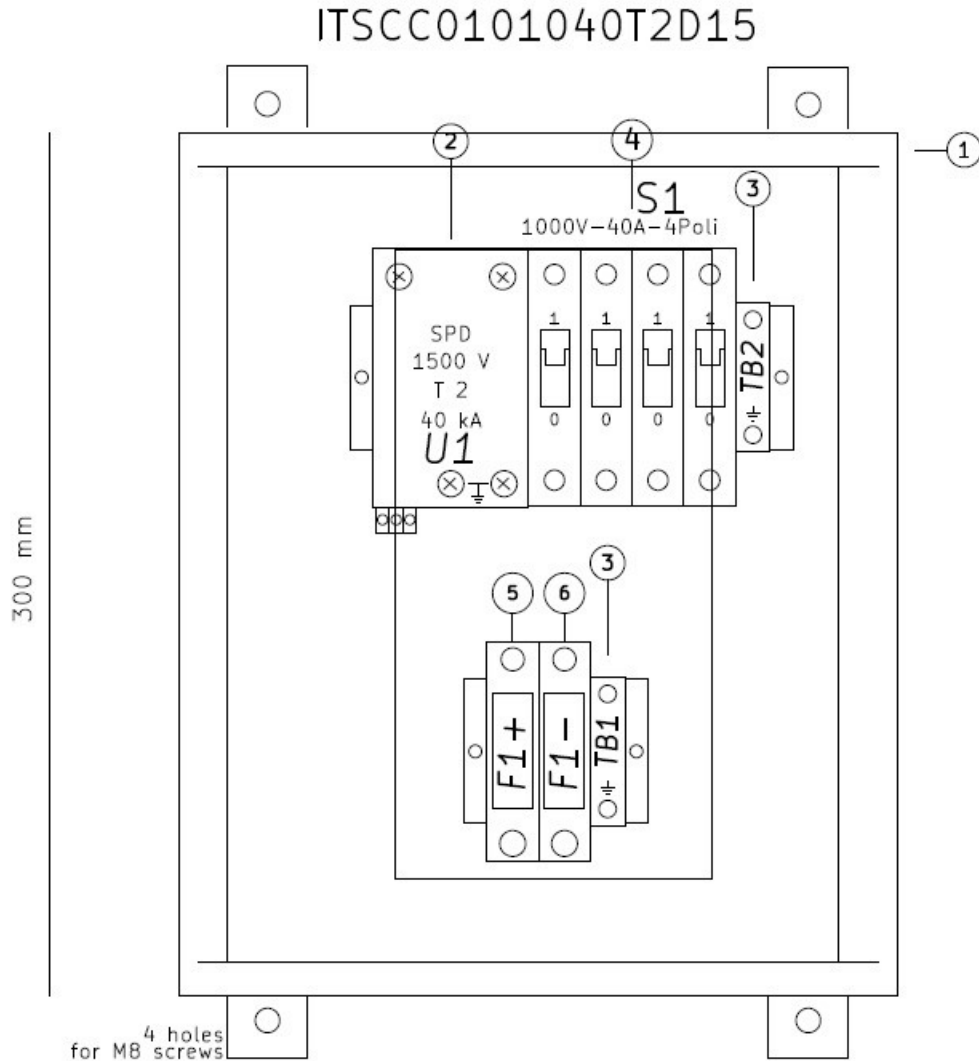

N°	DESCRIPTION
1	ENCLOSER 300x250x140 HxBxP
2	Scaricatore di Protezione SPD 1500V 40 kA T2
3	BLOCCO MORSETTO PE
4	SEZIONATORE MAGNETOTERMICO 40A 1000V
5	SEZIONATORE FUSIBILE Ingresso STRINGA+ 10x38 1000V 15A
6	SEZIONATORE FUSIBILE Ingresso STRINGA- 10x38 1000V 15A

5.2 Bottom View

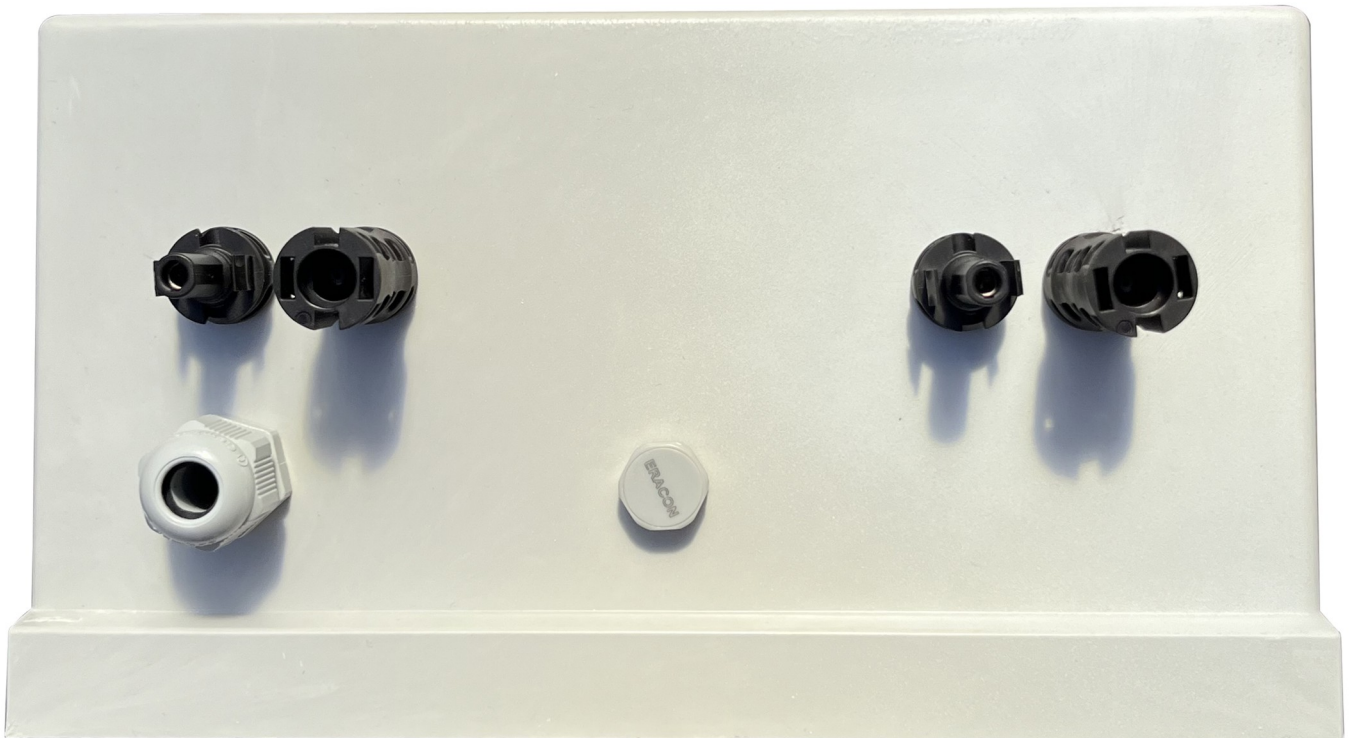
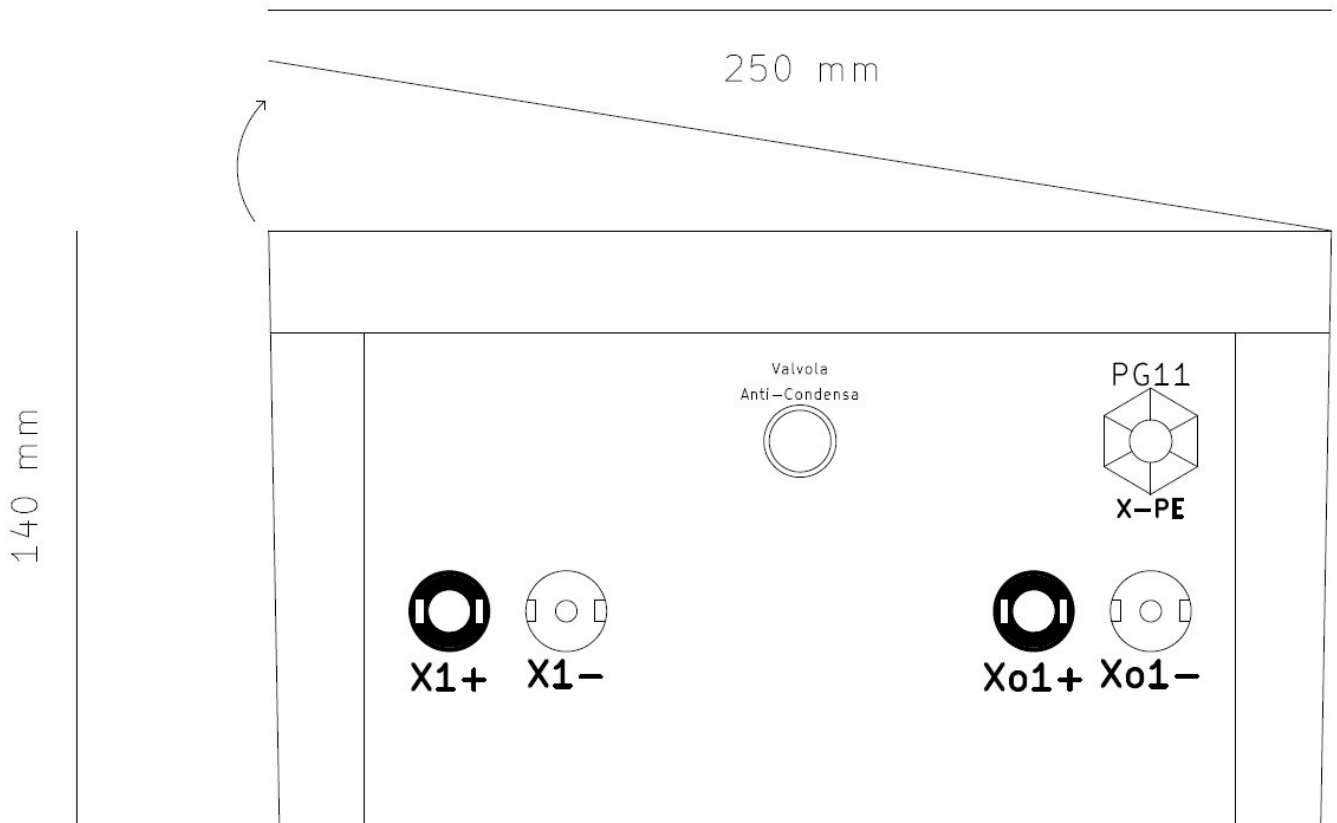



	IMPORTANT	<p>Each box will be accompanied by the following documentation :</p> <ul style="list-style-type: none">• electrical diagram• front panel layout• bottom connections• documentation relating to assembly <p>Furthermore, the testing certificate will be provided for each panel.</p> <p>In accordance with the "IEC 62790 chapter 4.2" standard, in the panel there is a label with the following information :</p> <ul style="list-style-type: none">• Name and mark of origin of the manufacturer (SolarBox)• Identification of the type / product code• CE mark and lot• Polarity <p style="text-align: center;"><u>THE LABEL MUST NEVER BE REMOVED</u> <u>under penalty of invalidation of the guarantee</u></p>
---	------------------	--

5.3 Naming Convention

Descrizione

IT	Italia
SCC	Famiglia di quadri
01	Numero di Stringhe in INGRESSO
01	Numero di stringhe in USCITA
040	Interruttore magnetotermico PRESENTE
T2	Tipo di scaricatore
D	Doppio fusibile
15	Corrente massima dei fusibili

5.4 Staubli MC4 Connectors



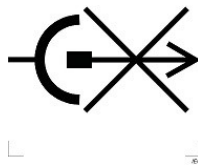

	<p>IMPORTANT</p>	<p>STAUBLI MC4 Male connectors and FLEX-SOL cables ARE NOT supplied. Recommended connectors and cables must be purchased separately and wiring properly.</p>
	<p>IMPORTANT</p>	<p>We are not responsible for the consequences resulting from the use of non-original spare parts and / or non-compliant products that do not comply with the instructions written in this manual.</p>

IMPORTANT

**In accordance with the "IEC 62790 - chapter 4.2" standard :
Before connecting/disconnecting any MC4, disconnect the equipment. Check that there is no voltage!**

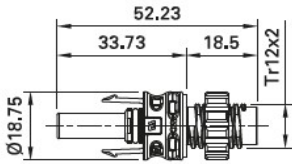
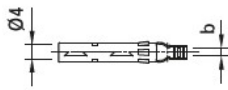

Cables and Connectors

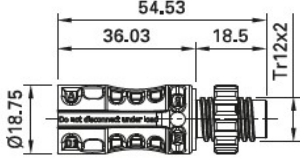
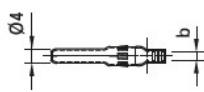
<p>FEMALE Connector</p>	<p>FEMALE: MC4 PV-ADB4-EVO 2/6-UR Connected to the Retrofit Box</p>
<p>PV-ADB4-EVO 2</p>  	 
<p>MALE Connector Recommended</p>	<p>MALE: MC4 PV-ADS4-EVO 2/6-UR NOT supplied</p>
<p>PV-ADS4-EVO 2</p>  	 

6 TECHNICAL DATA

6.1 Parameters

PARAMETERS	
Model Name	ITSCC
Rated DC Voltage	x
Input Strings	x
Max. Input Current	x
Range of measurement	x
Communication Protocol	x
Input/output Connection	MC4 or glande
Conductor Cross Section	x
Range Current Sense	x
Accuracy	x
Current Reading Typology	x
Terminal Type	MC4 or gland

6.2 Mechanics Characteristics

MECHANICS CHARACTERISTICS	
Operating Temperature	-10 °C to 70 °C
Operating Altitude	0 to 4000 meters slm
Operating Humidity	0 to 95% without condensation
Protection Degree	IP65
SPD Protection	x
Weight	See table depending models
Dimensions	See table depending models

6.3 Dimensions and Weight

Dimensions and Weight			
Model	Dimensions [mm] (W x H x D)	Net Weight of the BOX only [Kg]	Complete Packaging Weight [Kg]
ITSCC0101040T2D15	x	x	x

7 MAINTENANCE



Maintenance

All the installation and wiring connections should be performed only by qualified technical personnel. Only authorized personnel can access the panel. All maintenance and technical assistance work must be carried out by authorized "Specialized Personnel".

Please ensure the DC and AC sources are both disconnected, and the shell of device is securely grounded to avoid electric shock during maintenance or installation of the device.

All inspections and tests must be performed with controls and equipment de-energized, disconnected and isolated from accidental contact with live parts, and all plant safety procedures must be followed.

Please do not touch the live parts of the input and output sides to avoid electric shock when checking or maintaining the device.

Before carrying out maintenance, disconnect all cables from the panel.

Check periodically (by qualified personnel) tightening torque on screws. Re-tighten if it is necessary

